

CATALOGUE 2026

# NFCSTOCK

RFID MANUFACTURER & WORLDWIDE SHIPPING

**Imasi Desarrollos Informaticos e Investigacion SL**

Antoñita Jimenez 20, 28019, Madrid, Spain

+ 34 614853169

OPTIONAL COLOR 

OPTIONAL COLOR 

### RFID Wooden Card



### RFID Wooden Tag



### High Quality Hotel Waterproof Wooden Card

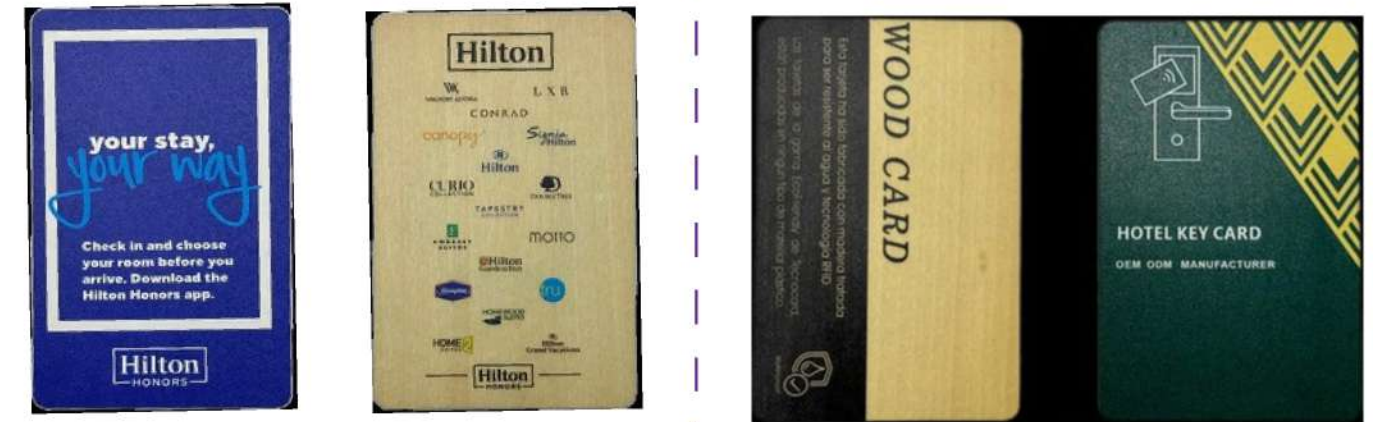

MORE Wooden Material CAN BE CUSTOMIZED

MORE STYLES CAN BE CUSTOMIZED



Product Introduction Stock Material available in: Bamboo, Basswood, Sapele, Cherry, and Black Walnut. Product features: Earth friendly and works like traditional plastic cards, but they are 100% PVC free. Wooden RFID cards are durable, reusable, waterproof, and recyclable. Our Eco friendly wooden RFID Keycards feature an embedded chip that can be made compatible with any door locking system. Chip types: MIFARE Classic 1K /4K, ICODE SLIX/S,

NTAG213/215/216, Ultralight C etc Printing/Craft: Customized by either laser engraving, silkscreen printing, and 4-color process printing. Custom sizes and shapes available!

## ISO Printable White Card



OPTIONAL COLOR

## RFID Leather Card



MORE STYLES CAN BE CUSTOMIZED



### Product Introduction

Thin card  
Material: PVC  
Thick card:  
Material: ABS +PVC  
Colour: white (customize acceptable)  
feature

Can seal LF/HF/UHF etc, variety frequency chip inside the card, the surface can be finished with silk print, offset, laser, ink jet and other personal processes of customized. Thick card can be sealed with two magnets

Chip types: TK4100, EM4200, EM4305, T5577, HDX 7999, HITAG S256, FM11RF08, NXP S50, NXP S70, Compatible S70, I CODE SLI, ULTRALIGHT, ULTRALIGHT C, NTAG 213, D21, D41, D81, ALIEN H3  
Temperature: -20-50°C

Application: Canteen selling food system, patrol system, attendance system, access system, parking system. Enterprise one card payment and other RFID field, usually used for safety requirement not high occasions.



## UHF RFID LABELS

OPTIONAL COLOR



	Model: RF-9610 Size: 44.45*10.32mm	Chip: H3 Reading Distance: 3m
	Model: RF-9620 Size: 27*9.7mm	Chip: H3 Reading Distance: 2m
	Model: RF-9629 Size: 22.5*22.5mm	Chip: H3 Reading Distance: 3.5m
	Model: RF-9634 Size: 44*46mm	Chip: H3 Reading Distance: 6m
	Model: RF-9640/9740 Size: 94.8*8.15mm	Chip: H3/H4 Reading Distance: 6m
	Model: RF-H Size: 95*3mm	Chip: H3 Reading Distance: 3.5m
	Model: CD disc tag Size: 20mm Od: 36mm	Chip: M4 Reading Distance: 1.5m
	Model: RF-J41 Size: 12*12mm	Chip: M4 Reading Distance: 0.22m

### Product Introduction

Material: paper, PET, PVC, ABS  
Colour: White  
feature

Chip types: UCODE, GEN2, UCODE HSL, IMPINJ MONZA,  
Working temperature:  
Application: cargo supplying logistics management, parcel and postage service, logistics warehouse management, Library etc.

## HF INLAY

	Model: RF-320 Size : 45*76mm	Chip: HXP Ultralight/Fo8
	Model: RF-Arizon Size : 45*45mm	Chip: HXP S50 Ultralight/Fo8
	Model: RF-23 Size : 12mm	Chip: Ntag203 Reading Distance: 1.5cm
	Model: ZAT Size : 41*72.6mm	Chip: HXP S50/Ultralight/Fo8
	Model: AZ-U Size : 41*72.6mm	Chip: HXP S50/Ultralight/Fo8
	Model: RAB Size : 25*75.6mm	Chip: HXP S50/Ultralight/Fo8
	Model: RAB-2 Size : 40*40mm	Chip: HXP S50/Ultralight/Fo8
	Model: Arizon-G Size : 22.5*38mm	Chip: HXP S50/Ultralight/Fo8



### Product Introduction

Material: paper, PET, PVC, ABS  
Colour: white  
feature

Chip types: MF S50, MF S70, NTAG 203, ULTRALIGHT C, I CODE SLI/ SLI-S/SLI-L/SLIX, ALIEN H3, IMPINJ M4/M5 and other variety style compatible chip  
Working temperature: -20-80°C

Application: cargo supplying logistics management, parcel and postage service, logistics warehouse management, Library, Brand security protection etc.

# WRISTBAND SERIES

OPTIONAL COLOR 

### Product Introduction

### Material of sealing:

ABS+Nylon, Silicone, PVC, Tyvek paper, PP Synthetic Paper, Fabric etc.

### Chip types :

TK4100, EM4200, EM4305, T5577, HDX 7999, HITAG1/2, HITAG S256, FM11RF08, NXP S50, NXP S70, Compatible chip S70, I CODE SLI, ULTRALIGHT, ULTRALIGHT C, NTAG213, D21, D41, D81, CPU, ALIEN H3, IMPINJ M4/M5

### Working Frequency:

125KHZ, 13.56MHZ, 860-960MHZ

### Reading Distance

: 1-10cm

### Printing:

Available in any color and full-color graphics on both side. Can printed UID & serial number

### Wristband size:

Length 145MM, 150MM, 160MM, 180MM, 200MM

### Width:

15MM, 20MM, 25MM or customized

### Feature:

Elastic fabric wristbands are stretchy, soft, and removable. can be re-used and replace cash, key etc.

### Application :

Extensive use on swimming pool, bath center, water proof routing inspection, field operation, Hospital patients management, Attendance management, One Card solution etc.

## RFID Elastic PVC Wristband



## RFID Elastic Wristband



## RFID Elastic Wristband



## RFID Fabric PVC Wristband



OPTIONAL COLOR 

OPTIONAL COLOR 

## RFID PP Synthetic Wristband



## RFID Tyvek Wristband



## RFID PVC Wristband



## Disposable wristband

### Disposable wristband Mother and Child

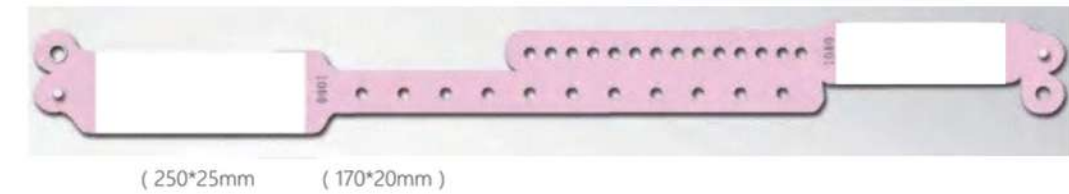

### Disposable wristband PVC

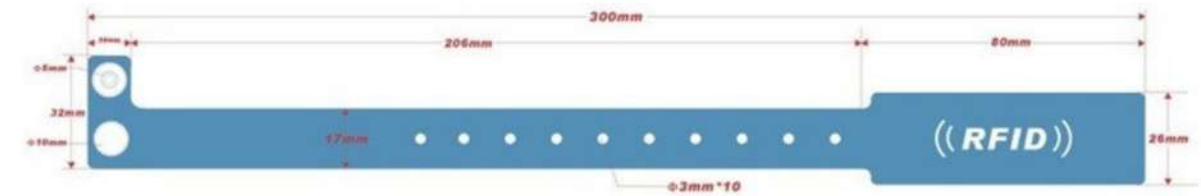

### Disposable wristband Synthetic paper

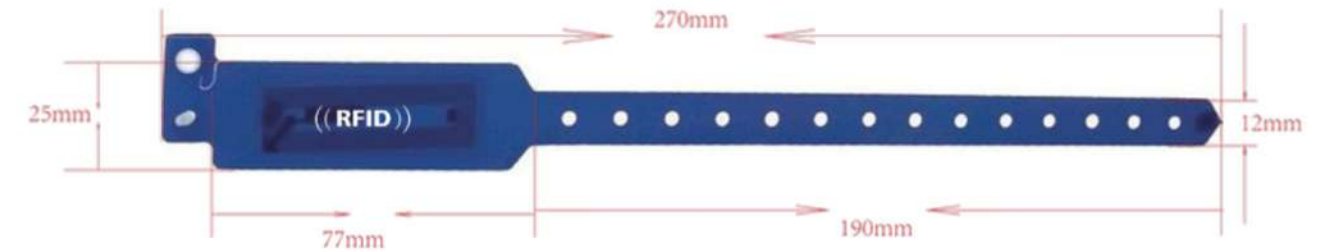

### Disposable wristband Thermal paper

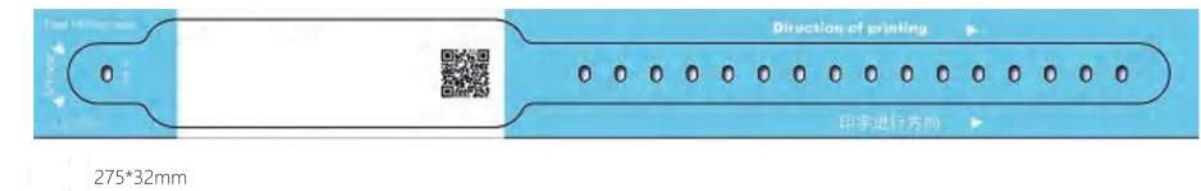

### Disposable wristband tyvek paper



#### Product Introduction

Material : Silicone, Paper Synthetic, Tyvek, PVC, Vinyl and Fabric..

Colour: Customizabel.

Application: Festivals, Waterparks, Swimming Pools, Events, Fitness Centers, Access Control Systems, Spas, Gyms, Hospitals, Clubs, and Contactless Payment Systems

Silicone Wristband

OPTIONAL COLOR

G01 Silicone wristband oval dial (ø45,ø55,ø60,ø65)

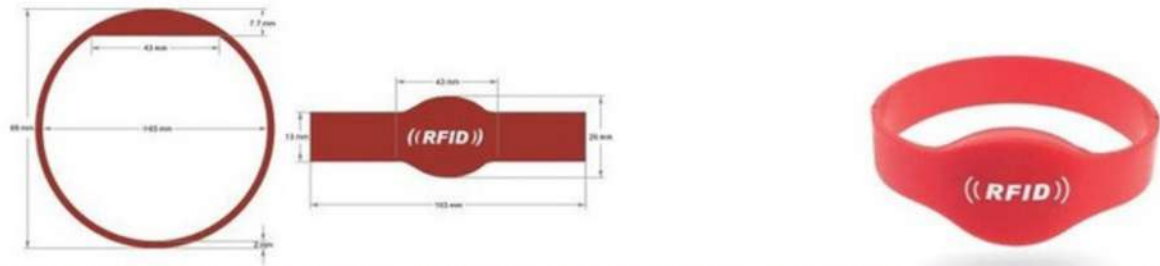

G02 Silicone wristband round dial (ø55,ø62,ø65,ø74)

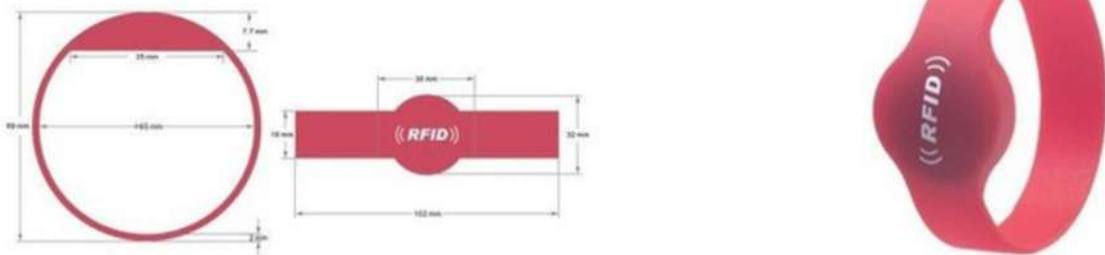

G03 Silicone wristband small diameter strap (ø60,ø65,ø67)

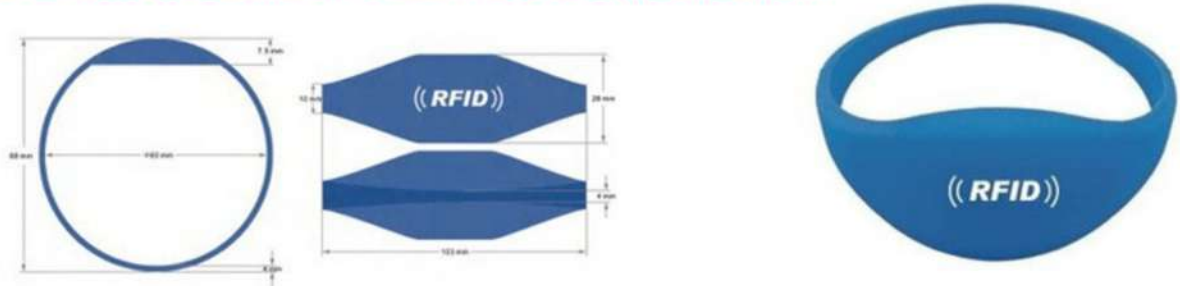

G04 Silicone wristband double dial

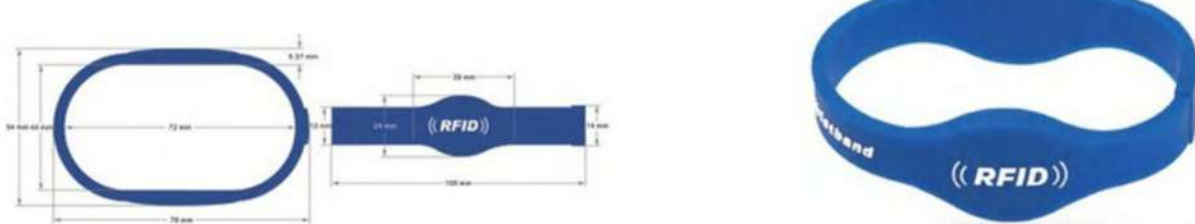

G05 Silicone wristband dual frequency

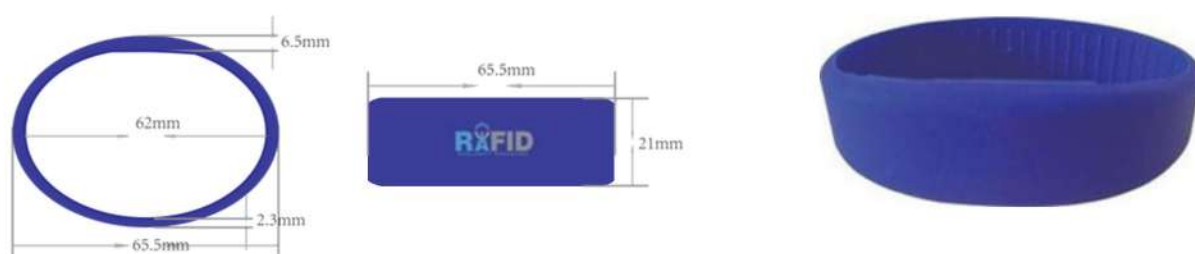

OPTIONAL COLOR

G06 Silicone wristband concave-convex hasp

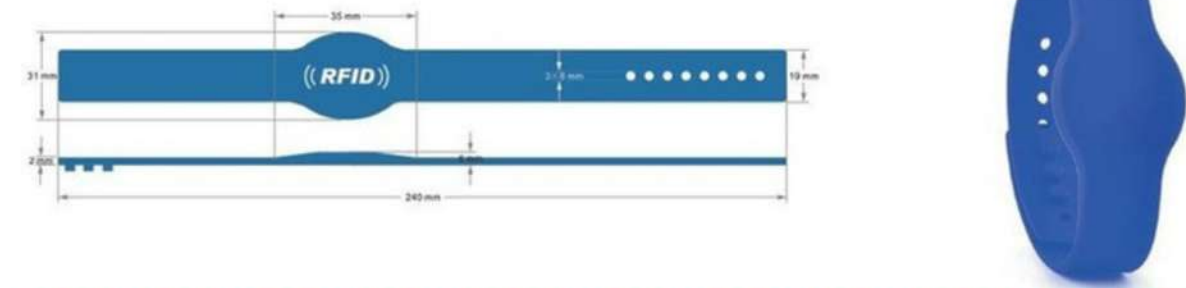

G07 Silicone wristband metal hasp

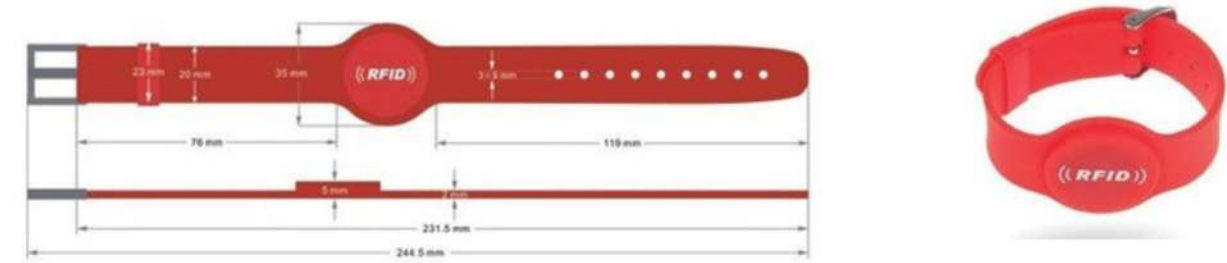

G08 Silicone wristband flap

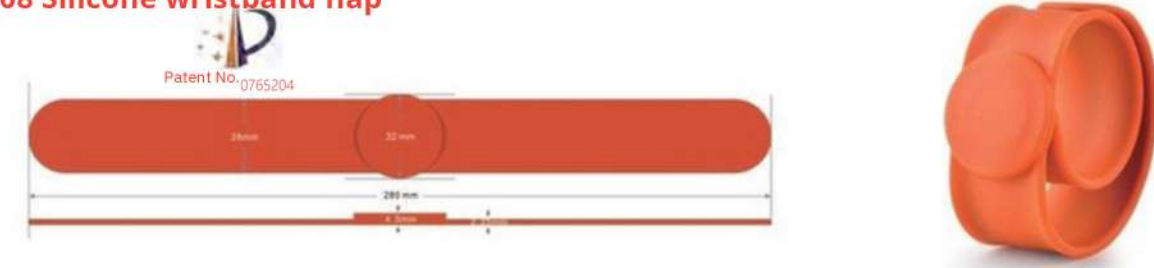

G09 Silicone wristband dual frequency

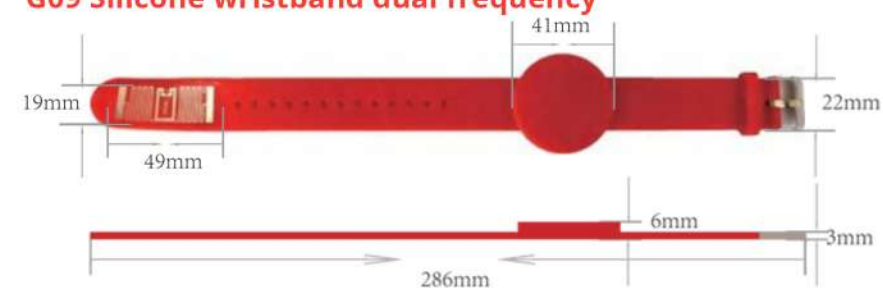

G10 Silicone wristband prevent dis-assembly

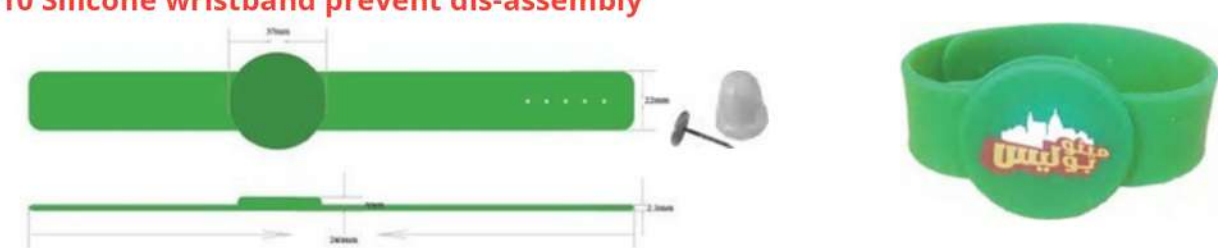

WRISTBAND

WRISTBAND

# LAUNDRY LABEL SERIES

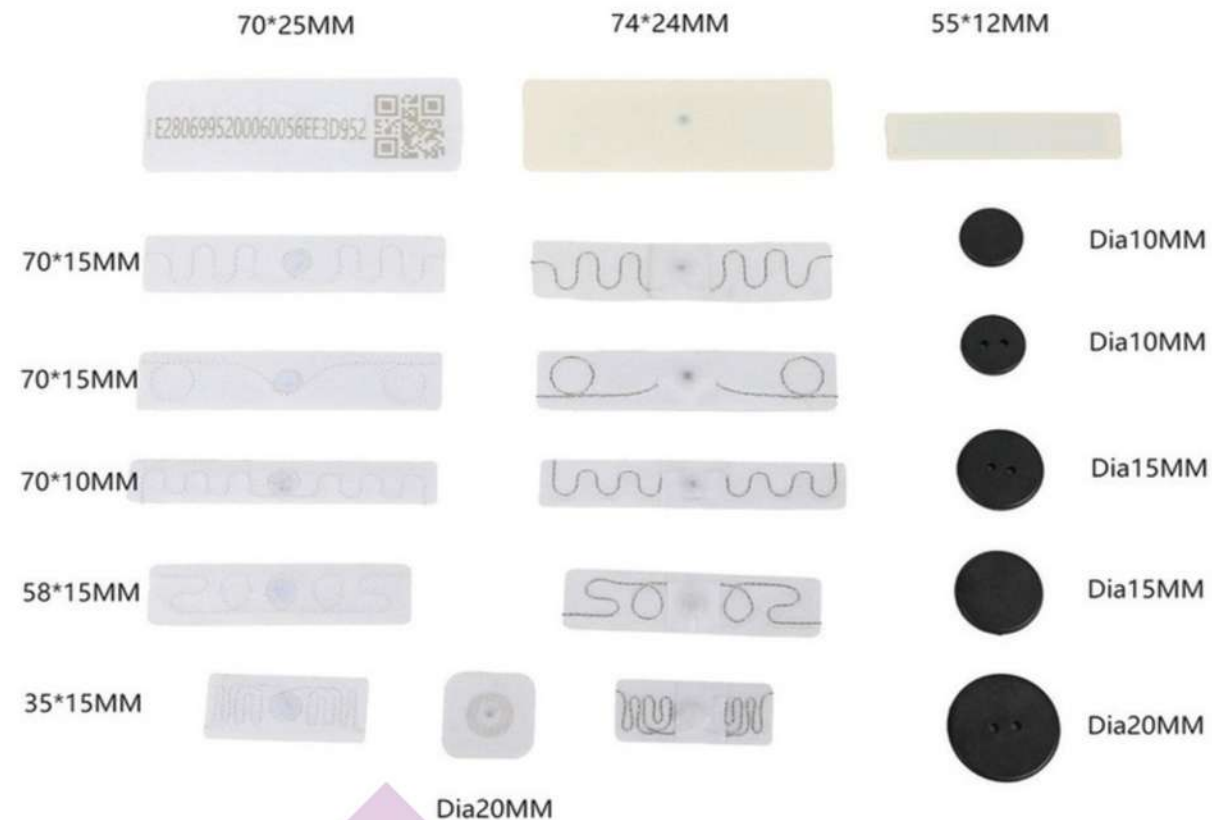

### Application

Industrial Washing Environments, Medical Apparel Management, Surgical Uniforms Management, Military clothing Management, Personnel Patrol Management, Managing Uniforms Management, Hotel Linen Management



OPTIONAL COLOR

## Textile Washing Tag

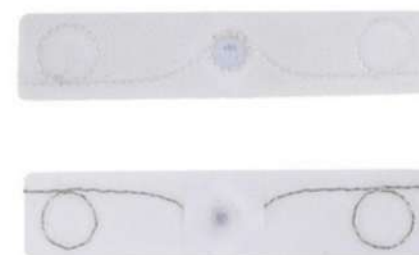

## RFID Silicone Laundry Tag



### product description

Material: environmentally friendly silicone  
 Colour: blue, white (Customizable in batches)  
 Packaging process: Integrated molding into silicone mold  
 Washing times: 100-150 times

### Product Features

Elastic, easy to use, waterproof, moisture-proof, shockproof, and high temperature resistant  
 Packageable chips: ALIEN H3,IMPINJ M4/M5  
 Operate temperature:-20~150°C  
 reading distance:1-3m  
 Application scope: clothing industry, cloth printing and dyeing industry, washing industry, medical logistics and other professional fields

## RFID Woven Tag

### product description

INLAY: Material:WashedRibbon, Adhesive Tape, Polyester Ribbon, Dupont Paper, Non-Woven Fabric Plus PET Aluminum Etched INLAY

Packaging process: The material of the ribbon can be divided into adhesive and pocket process. Tape and polyester tape, non-woven fabric, and white cardboard are all adhesive.

### Product Features

It is environmentally friendly, non-toxic and harmless, with good waterproof, dustproof and anti-bending properties. The surface can be printed with QR codes, LOGOs, automatic writing of codes, etc. Various sizes can be customized, and near-field multi-label recognition is possible.

Packageable chips: MIFARE S50/S70,FM1108,ICODE2,TI2048, LR12K,ALIEN H3,IMPINJ M4/M5

Operate temperature:-10~65°C

reading distance:0.5-3m

Application scope: clothing warehousing, clothing anti-theft, anti-counterfeiting, anti-crossing goods, VIP customer management



# RFID ANTI-METAL LABEL SERIES

## Product Introduction

### Material:

FR4, ABS,SILICONE, CERAMIC,EPOXY,+PE sponge, Absorbing radio material etc.

### Chip types:

Alien series, IMPINJ series, NXP I-CODE SLI/TI/S50/F1108/NTAG 213

### Response frequency:

125khz, 13.56mhz,860-960mhz

### Application introduce:

RFID ANTI METAL TAG is a such RFID tag which is sealed by a special absorbing radio waves material, it can solve the problem which the normally RFID tag can't be placed on the surface of metal. This product can be waterproof, anti acid, alkali resistant, Anti collision and can be used outdoor. Will have excellent read performance when stick the RFID anti metal tag on the surface of metal. Our research and development of anti metal tags, the use of special circuit design can effectively prevent the interference of metal RFID signals, to achieve positive resistance to metal effects. The soft anti-metal electronic label can be used for the management of cylinders. It can effectively manage the cylinders of all kinds of dangerous goods by RFID. And can know actually the position, state and annual inspection and other information of the cylinders, Thus effectively strengthened the safety of the people's property, while achieving the anti-counterfeiting of the cylinder. FR4 anti-metal label for multi-media applications UHF passive PCB anti-metal tags, with high temperature, anti-corrosion, anti-moisture, anti-collision used in outdoor harsh environment.

### Application:

Cylinders, gas tank, vehicle brand, machine identify, mold tracking, metal container, outdoor electric equipment, mechanical assets management, parking vehicle management, quality management, Entry and exit controlling management and other field.



ANTI METAL TAG

OPTIONAL COLOR

## UHF High Temp 150°C Anti-Metal Tag



Size: 56\*35



Size: 48\*30mm



Size: 48\*36mm

### Product Introduction

Material: ABS+PE SPONGE or PPS+ Ceramic  
Colour: black/white Size: Customizable Packaging method: Ultrasonic Installation method: paste/screw

### Product Features

Waterproof, dustproof, durable, can package multi-frequency chips, adopts anti-metal design  
Packageable chips: ALIEN series, IMPINJ series  
NXP I-CODE SLI/TI/S50/F1108/NTAG 213  
Operate temperature: -20~150°C  
reading distance: 1-10m  
Scope of application: Logistics and transportation, traffic management, vehicle management, asset management, power equipment inspection

## ABS Anti-Metal Tag



Size: 125\*21\*12.5mm



Size: 116\*30\*10mm

## Gas bottle label



Size: 62\*32\*10mm

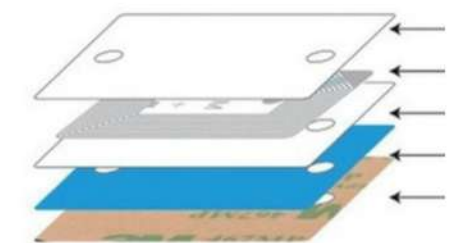

ANTI METAL TAG

# RFID PCB Tag



Type: SR-PD05 微型 Tag  
Chip: I CODE SLIX  
Size:  $\Phi 5\text{mm}$   
Frequency: 13.56MHZ  
Mobile phone reading distance: 10mm



Type: SR-PD1309 Tag  
Chip: I CODE SLIX  
Size:  $\Phi 13 \times \Phi 9\text{mm}$   
Frequency: 13.56MHZ  
Reader: 30mm



Type: SR-P17512 Tag  
Chip: I CODE SLIX  
Size:  $17.5 \times 12\text{mm}$   
Frequency: 13.56MHZ  
Reader: 40mm



Type: SR-PD18 Tag  
Chip: I CODE SLIX  
Size:  $\Phi 18\text{mm}$   
Frequency: 13.56MHZ  
Reader: 45mm



Type: SR-PD1912 Tag  
Chip: I CODE SLIX  
Size:  $\Phi 19 \times \Phi 12\text{mm}$   
Frequency: 13.56MHZ  
Reader: 40mm



Type: SR-P2014 Tag  
Chip: I CODE SLIX  
Size:  $20 \times 14\text{mm}$   
Frequency: 13.56MHZ  
Reader: 40mm



Type: SR-PD2009 Tag  
Chip: I CODE SLIX  
Size:  $\Phi 20 \times \Phi 9\text{mm}$   
Frequency: 13.56MHZ  
Reader: 50mm



Type: SR-PD2409 Tag  
Chip: I CODE SLIX  
Size:  $\Phi 24 \times \Phi 9\text{mm}$   
Frequency: 13.56MHZ  
Reader: 60mm



Type: SR-P3018 Tag  
Chip: I CODE SLIX  
Size:  $\Phi 30 \times \Phi 18\text{mm}$   
Frequency: 13.56MHZ  
Reader: 70mm



Type: SR-P3509 Tag  
Chip: I CODE SLIX  
Size:  $\Phi 35 \times \Phi 9\text{mm}$   
Frequency: 13.56MHZ  
Reader: 80mm



Type: SR-P3618 Tag  
Chip: I CODE SLIX  
Size:  $\Phi 36 \times \Phi 18\text{mm}$   
Frequency: 13.56MHZ  
Reader: 80mm

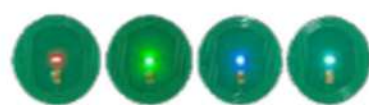

Type: SR-PL21 Glowing Object Hunt Tag  
Chip: ISO15693Chip  
Size:  $\Phi 21\text{mm}$   
Frequency: 13.56MHZ  
Reader: 30mm  
LED colors: red, yellow, blue, green, white, purple, pink, pink-purple  
Features: Light up the Tag by sending commands to quickly find the target item



Type: SR-P5442 Tag  
Chip: I CODE SLIX  
Size:  $\Phi 54 \times \Phi 42\text{mm}$   
Frequency: 13.56MHZ  
Reader: 90mm



Type: SR-P22 UHF Tag  
Chip: R6  
Size:  $\Phi 22\text{mm}$   
Frequency: 860MHZ-960MHZ  
4W Fixed Reader: 0.5m (Different readers have differences)  
R2000 Handheld Reader: 0.3m (Different readers have differences)



Type: SR-P10709 UHF Tag  
Chip: U9  
Size:  $107 \times 9\text{mm}$   
Frequency: 860MHZ-960MHZ  
4W Fixed Reader: 20m (Different readers have differences)  
R2000 Handheld Reader: 20m (Different readers have differences)

OPTIONAL COLOR



# NFC FPC Tag



Type: SR-F0404 Tag  
Chip: NTAG 213  
Size:  $4 \times 4\text{mm}$   
Frequency: 13.56MHZ  
Mobile phone reading distance: 5mm



Type: SR-F0505 Tag  
Chip: NTAG 213  
Size:  $5 \times 5\text{mm}$   
Frequency: 13.56MHZ  
Mobile phone reading distance: 10mm



Type: SR-FD6 Tag  
Chip: NTAG 213  
Size:  $\Phi 6\text{mm}$   
Frequency: 13.56MHZ  
Mobile phone reading distance: 10mm



Type: SR-F0606-K Anti-Metal Tag  
Chip: NTAG 213  
Size:  $6 \times 6\text{mm}$   
Frequency: 13.56MHZ  
Mobile reading distance: On Metal 5mm



Type: SR-F1004 Tag  
Chip: NTAG 213  
Size:  $10 \times 4\text{mm}$   
Frequency: 13.56MHZ  
Mobile phone reading distance: 10mm



Type: SR-FD8 Tag  
Chip: F08S  
Size:  $\Phi 8\text{mm}$   
Frequency: 13.56MHZ  
Mobile phone reading distance: 15mm



Type: SR-FD8 Tag  
Chip: I CODE SLIX  
Size:  $\Phi 8\text{mm}$   
Frequency: 13.56MHZ  
Reader: 20mm



Type: SR-FPD10 Tag  
Chip: NTAG 213  
Size:  $\Phi 10\text{mm}$   
Frequency: 13.56MHZ  
Reader: 15mm



Type: SR-FD10-K Anti-Metal Tag  
Chip: NTAG 213  
Size:  $\Phi 10\text{mm}$   
Frequency: 13.56MHZ  
Reader: On Metal 10mm



Type: SR-FD15 Tag  
Chip: NTAG 213  
Size:  $\Phi 15\text{mm}$   
Frequency: 13.56MHZ  
Reader: 25mm



Type: SR-FD1004 Tag  
Chip: NTAG 213  
Size:  $\Phi 10 \times \Phi 4\text{mm}$   
Frequency: 13.56MHZ  
Reader: 20mm



Type: SR-F1006 Tag  
Chip: NTAG 213  
Size:  $10 \times 6\text{mm}$   
Frequency: 13.56MHZ  
Reader: 15mm



Type: SR-FD20 Tag  
Chip: NTAG 213  
Size:  $\Phi 20\text{mm}$   
Frequency: 13.56MHZ  
Reader: 40mm



Type: SR-F0812 Tag  
Chip: NTAG 213  
Size:  $8 \times 12\text{mm}$   
Frequency: 13.56MHZ  
Reader: 20mm



Type: SR-F0918 Tag  
Chip: NTAG 213  
Size:  $9 \times 18\text{mm}$   
Frequency: 13.56MHZ  
Reader: 30mm

NFC PCB TAG

NFC PCB TAG

## RFID Flexible Printable Anti-Metal Tag

OPTIONAL COLOR 



Size: 70\*30\*1.5mm, 80\*40\*1.5mm

**Product Introduction:**  
 Material: Sticky paper, PE+Absorbing radio waves material (ferrite)  
 Colour: white  
 Size: Multiple size available, customize acceptable  
 Firming way: self-adhesive glue  
**feature:**  
 High Protection Class IP65, could print by printer (compatible with Sato Gta412e, Toshiba 5T etc) Can be auto written SN code, Ultra thin 0.88mm, role delivery  
 Sealing chip: Alien series, IMPINJ Series  
 Working temperature: -20-80°C  
 Read and write range: 0.5-2m  
 Application: water meter, IT server and equipment assets tracking, metal parts management, machine identification and management etc.

## UHF Ceramic Anti-Metal Tag

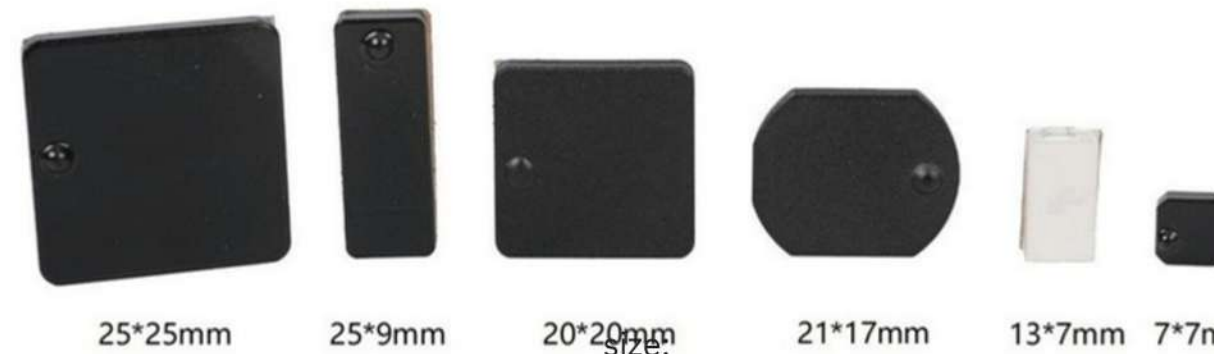

## UHF PCB Anti-Metal Tag



## Shelf Tag



**Product Introduction:**  
 Material: ABS+epoxy resin  
 Colour: Customizable  
 Size: 85\*22\*5mm  
 reading /writing distance: HF10-50cm UHF: 1-3m  
 chip style: U8/H9/I Code slix  
 STANDARD PROTOCOL: ISO18000-6C/15693  
 APPLICATION SCOPE: SMART LIBRARY, SMART STORAGE CONTAINER,

SMART COMPACT CABINET



K  
F



# RFID Key Tag INTRODUCTION

NEW

Transparent epoxy key fob



OPTIONAL COLOR

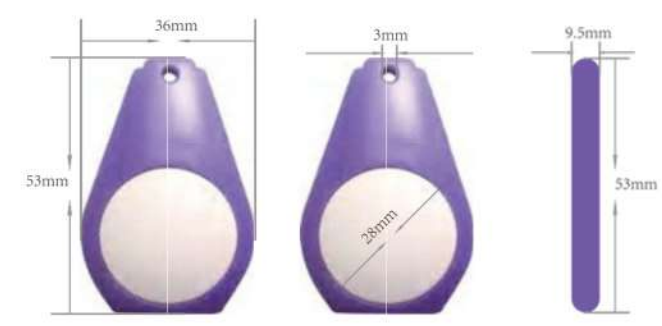
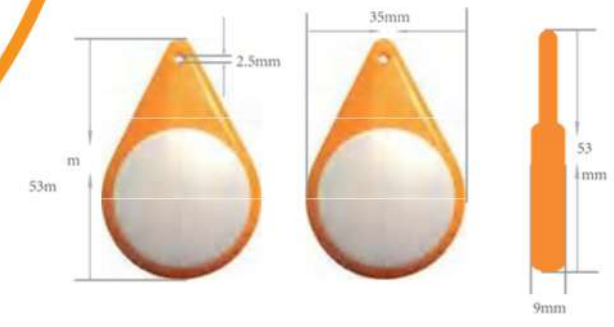
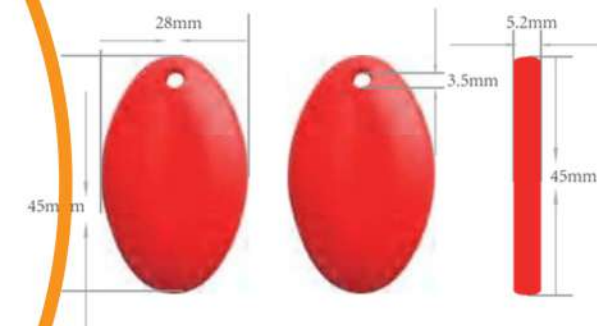
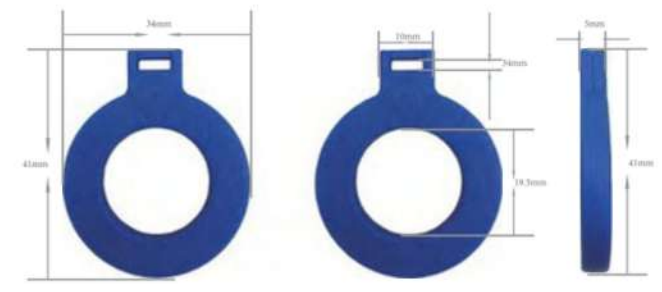
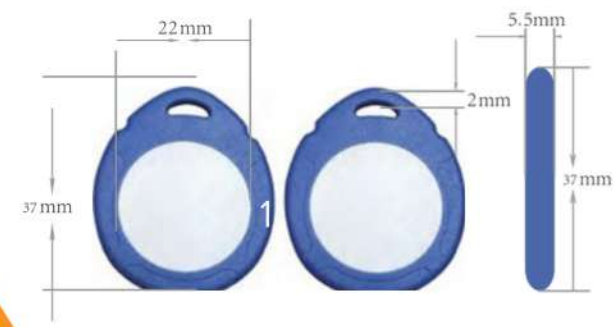

K  
F

OPTIONAL COLOR



OPTIONAL COLOR

K  
F

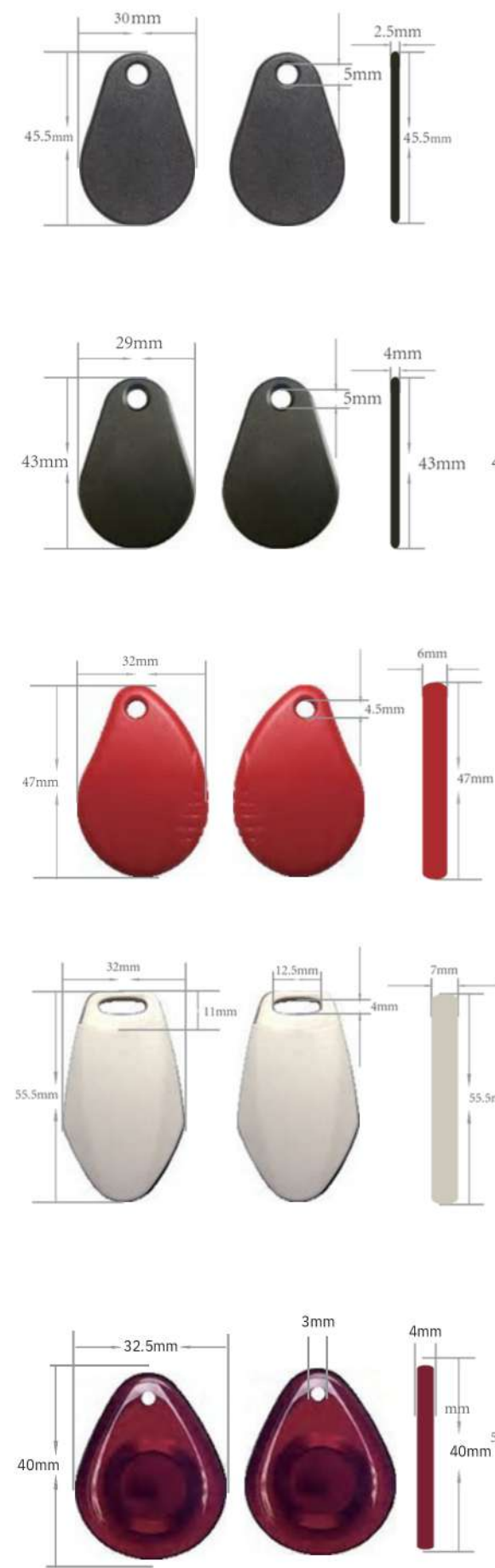
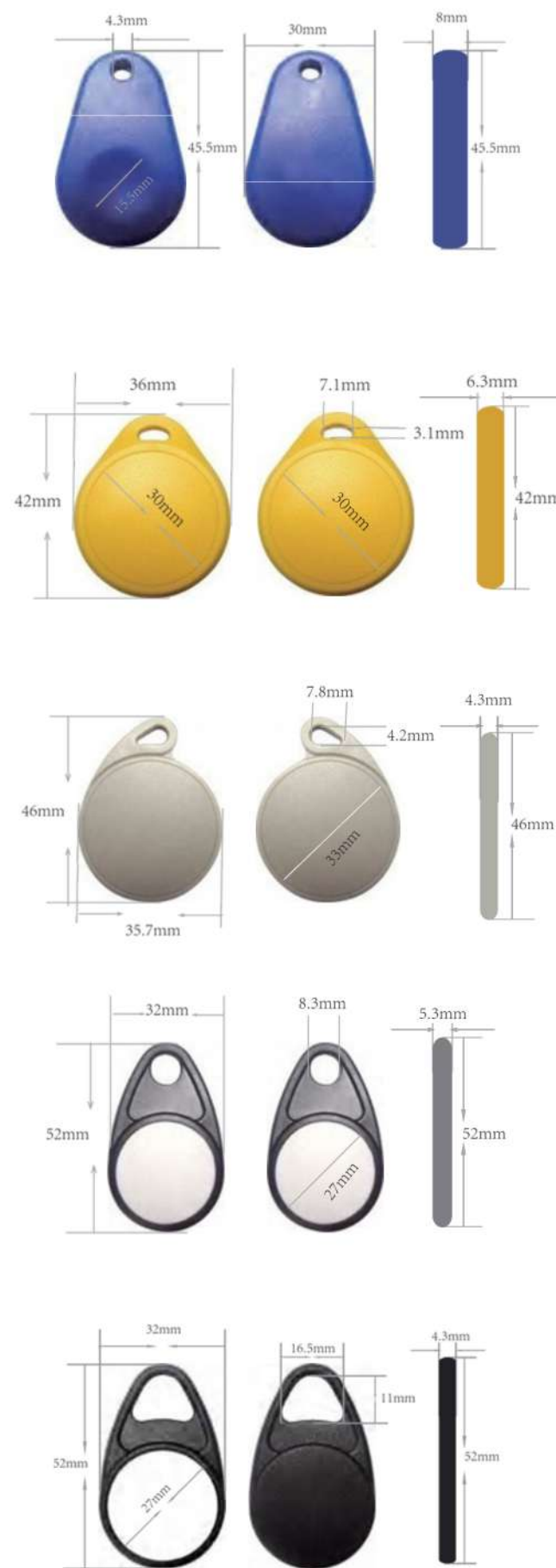

K  
F

# LEATHER KEY CHAIN

Luxury model and distinguished symbol

Leather/PU Material



**P01** Leather size : 60\*53\*7mm  
flat ring size : 32mm  
weight : 15g



**P02** Leather size : 67\*40\*6mm  
flat ring size : 35mm  
weight : 14g



**P03** Leather size : 70\*41\*6mm  
Alloy size : 16\*12\*8mm  
(circle : 32mm)  
weight : 16g



**P04** Leather size : 64\*35\*7mm  
flat ring size : 32mm  
weight : 22g



**P05** Leather size : 44\*36\*7mm  
flat ring size : 32mm  
weight : 16g



**P06** Leather size : 60\*55\*7mm  
flat ring size : 40\*28mm  
weight : 25g



**P07** Leather size : 113\*30\*8mm  
flat ring size : 41.6\*29mm  
weight : 15g



**P08** Leather size : 46\*34\*5mm  
flat ring size : 32mm  
weight : 7g



**P09** Leather size : 69\*39\*8mm  
flat ring size : 32mm  
weight : 17g



**P10** Leather size : 72\*42\*7mm  
flat ring size : 32mm  
weight : 17g



**P11** Leather size : 66\*38\*6mm  
flat ring size : 32mm  
weight : 25g



**P12** Leather size : 73\*45\*7mm  
flat ring size : 35mm  
weight : 23g

LEATHER KEY CHAIN



**P13** Leather size : 43\*35\*6mm  
flat ring size : 23mm  
weight : 7g



**P14** Leather size : 58\*36\*6mm  
flat ring size : 32mm  
weight : 8g



**P15** Leather size : 40\*36\*6mm  
Alloy size : 33\*12\*4mm  
weight : 7g



**P16** Leather size : 50\*40\*6mm  
Alloy size : 43\*21\*8mm  
weight : 25g



**P17** Leather size : 75\*41\*6mm  
flat ring size : 32mm  
weight : 9g



**P18** Leather size : 70\*41\*6mm  
Alloy size : 16\*12\*5mm  
(circle : 32mm)  
weight : 14.5g



**P19** Leather size : 65\*41\*5mm  
flat ring size : 32mm  
weight : 9g



**P20** Leather size : 46\*34\*5mm  
flat ring size : 32mm  
weight : 7g



**P21** Leather size : 46\*38\*6mm  
flat ring size : 32mm  
weight : 7g



**P22** Leather size : 55\*28\*3.5mm  
Alloy size : 26\*17\*7.5mm  
(circle : 32mm)  
weight : 16g



**P23** Leather size : 76\*35\*6mm  
flat ring size : 32mm  
weight : 9g



**P24** Leather size : 71\*21\*3mm  
flat ring size : 14mm  
weight : 3g

# COIN TAG SERIES ↘

**Product introduction**

**Material:**

According to the different use of choice ABS, PVC, PC or according to customer requirements using new materials

**Chip types:**

EM4200,EM4305,TK4100,T5577,HITAG1,HITAG2,HITAGS256,MIFARE S50/S70,FM1108,DESFIRE41/81,ICODE2,TI2048, TI256,NTAG213/215/216,LR12K,ALIEN H3,IMPINJ M4/M5

**Operating Frequency:**

125KHZ,13.56MHZ,860-960MHZ,Support dual frequency(ABS TAG 35/40/50/52,ABOVE PVC TAG 30)

**Feature:**

ABS / PC engineering materials used in packaging, ultrasonic sealing, moisture resistance, anti-corrosion, suitable for harsh environments. Round hole, hole can be installed in the fixed screw on the object.The appearance of small and exquisite, durable, do not fade, covered with cement or other non-metallic materials can also be nailed to the surface of the object, according to customer requirements to provide design, surface printing, silk screen, decal, ink-jet-printing and other post-technology.

**Application:**

Used in product identification, asset management, logistics tracking, biometrics, industrial automation, game chips, subway one-way ticket card, public security, security, postal, airport, railway, oil field, real estate property, bank, museum, water, electricity, gas Monitoring industry and so on. As long as any one involved in regular data collection and patrol the place, can be used to it.



OPTIONAL COLOR 

### Seal tag

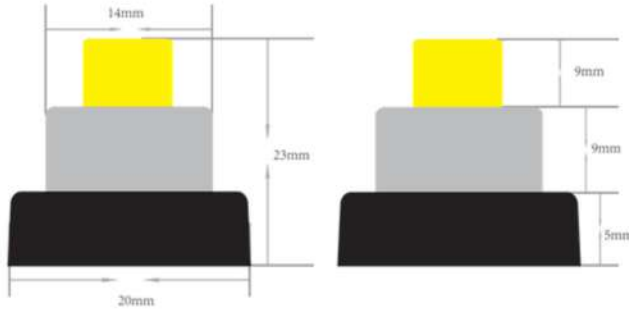

### UHF seal tag

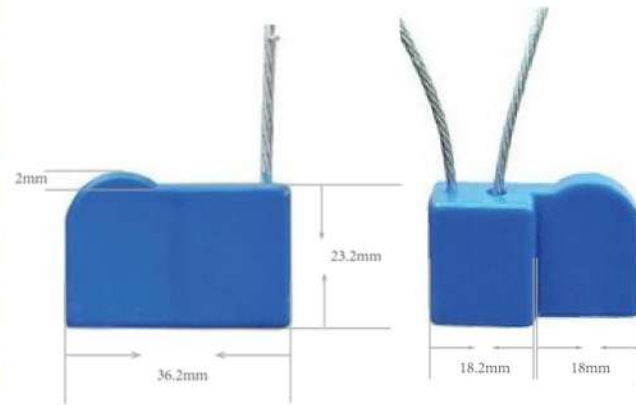

### Nail Tag

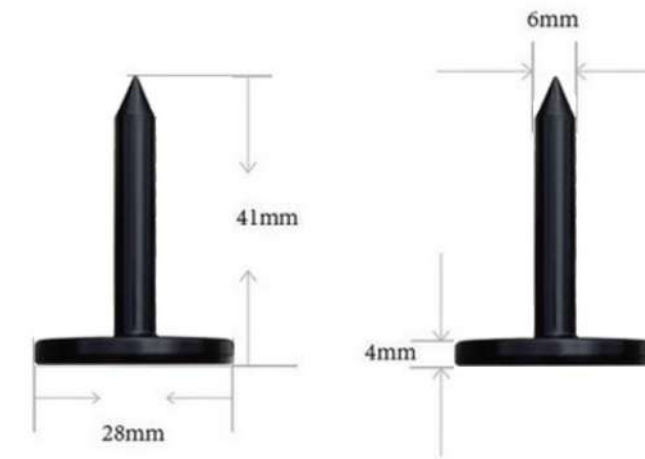

OPTIONAL COLOR 

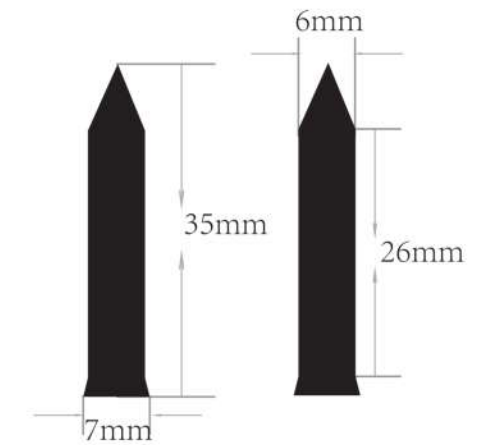

MORE STYLES CAN BE CUSTOMIZED

MORE STYLES CAN BE CUSTOMIZED



#### Product instruction

Material: PC+epoxy, wire  
 Colour:black, blue, red(customize available)  
 Installation method: lead suspension  
 Features:

Waterproof, Moisture resistance, To prevent vibration,  
 Acid and anti-aging, sealing line salt tolerance,  
 Chip types: TK4100, EM4200, EM4305, T5577,  
 FM11RF08, NXP S50, NXP S70, compatible S70,  
 I CODE SLI, ULTRALIGHT, ULTRALIGHT C,  
 NTAG 213/215/216, D21, D41,D81, ALIEN H3

Working temperature:-20-80°C  
 Application: For meter, bank, Chemical industry,water/power,  
 electricity,petrochemical,shipping,logistics, container and other  
 industries security and data privacy purposes.

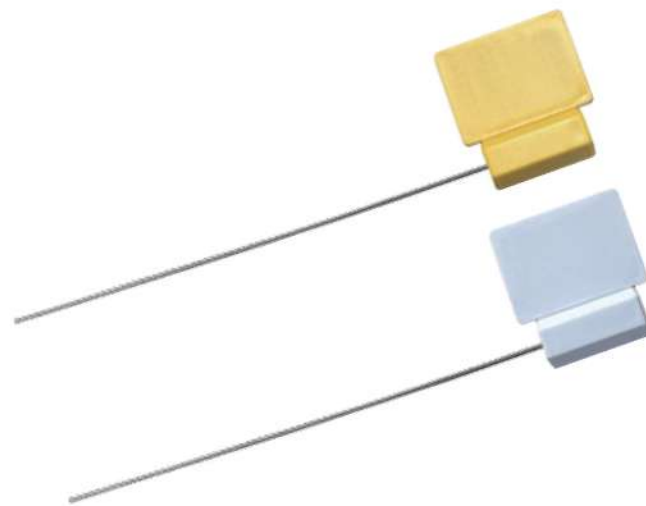

Product Introduction Material:ABS Colour:  
 black,white(customize acceptable) Features: Waterproof,  
 Moisture resistance, To prevent vibration, Acid and anti-aging,  
 can be inserted into wood or tree trunk,(drill a hole with driller  
 first, then hit the nail tag into the hole with Rubber hammer )  
 Chip types: TK4100,EM4200, EM4305, T5577, HDX 7999,

HITAG S256, FM11RF08, NXP S50, NXP S70,Compatible S70,  
 I CODE SLI, ULTRALIGHT, ULTRALIGHT C, NTAG 213, D21,D41,  
 D81, ALIEN H3

Working temperature:-20-50°C  
 Application: forestry(tree)management, rubbish management,  
 wood Identification, management and identification of industry  
 parts, property tracking and production and operation process  
 tracking.





ABS TAG-12

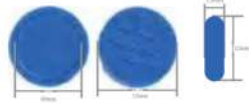

ABS TAG-20



ABS TAG-22

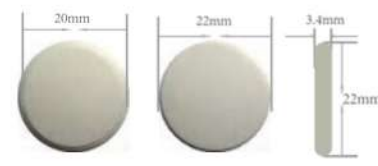

ABS TAG-25

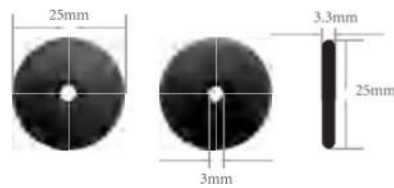

ABS TAG-30A

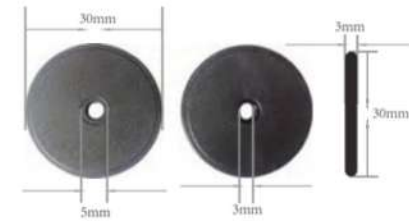

ABS TAG-30B

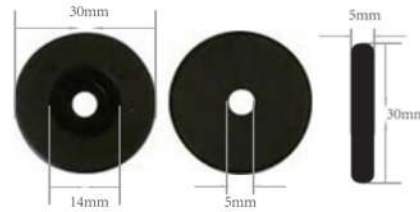

ABS TAG-27

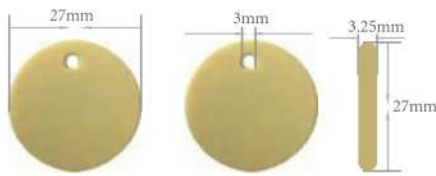

ABS TAG-32

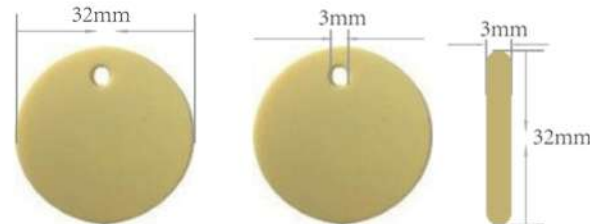

ABS TAG-35

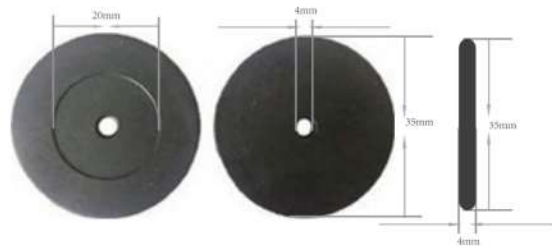

ABS TAG-40

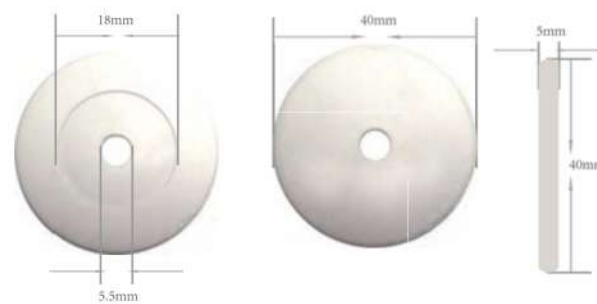

ABS TAG-52

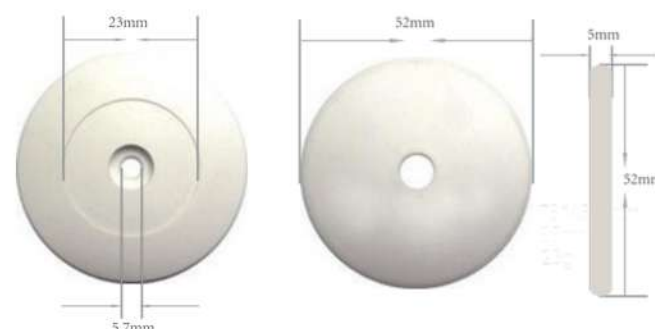

## PPS Industrial Application Tags



### product description

material : PPS  
 Colour: Colors can be customized (surface can be printed)  
 Size: can be customized ( φ15, φ20 , φ23.5, φ25.5, φ30 )

### Product Features

Patterns can be made on the surface, and adhesive can be added on the back to stick to the surface of the item.  
 Operate temperature: -30~130°C  
 marking, logistics tracking, power monitoring industry, etc.  
 Application scope: Industrial automation, product

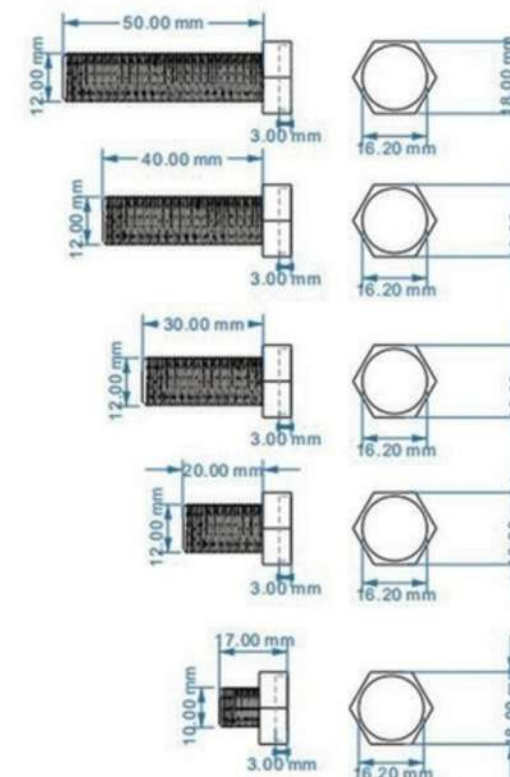

### product description

Packaging material: 304stainless steel  
 Size: can be customized  
 Packaging process: process embedding + epoxy resin potting  
 Appearance process: Laser available

### Product Features

Operate frequency: 840-960mhz  
 read/write distance: 20-100cm  
 Application scope: various industrial environments and equipment asset management industries

TAG

TAG

## PVC TAG-15

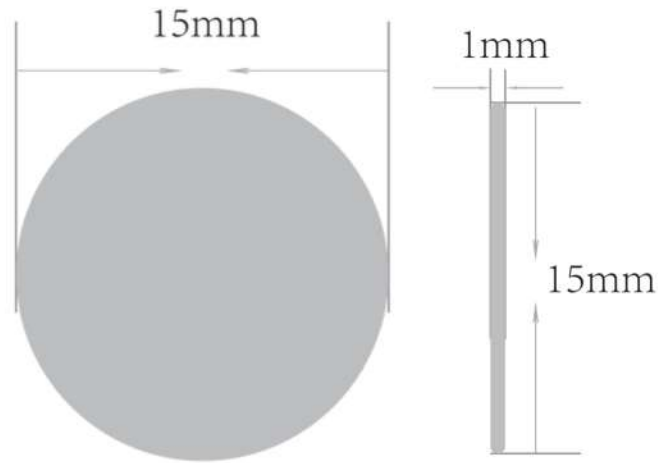

## PVC TAG-32

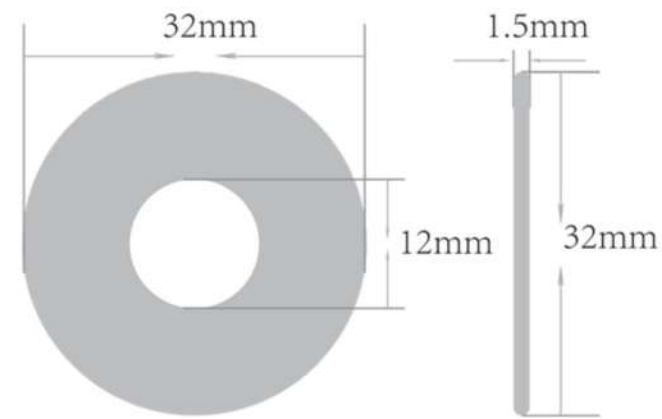

# ANIMAL TAG SERIES

Product introduction Material Ear tag:TPU+PA, Foot ring:ABS Glass tube:Biochemical glass Chip type EM4200,EM4305,TK4100,T5577,HITAGS256,SIC7999,FM1108,ICODE2-SLI-X,NTAG213/215/216,LR12K, ALIEN H3,IMPINJ M4/M5 Frequency 125KHZ,13.56MHZ,860-960MHZ Product introduction This type of label applies to pigs, cattle, sheep, pets, fish, chickens, ducks, pigeons and other animal management, as if the animals to send an animal electronic identity card, this animal electronic ID card attached to the detailed record All the important information of animals, which can be very convenient for these animals are very effective management, can quickly and accurately verify the animal transport, epidemic reporting and other information, effective control and prevention of many major animal epidemic, so that the livestock industry Benign healthy development track, animal husbandry operators a substantial increase in economic efficiency.This product is safe non-toxic, no smell, no stimulation, no pollution, chemical stability, anti-sun, no cracking, long life, do not stimulate the skin. Application Animal husbandry, laboratory, pet hospital and so on. Can be nailed to animal ears for animal management, population breeding, epidemic prevention, quarantine, cherish species tracking.

TAG

Specification: Ø13, Ø15,Ø18,Ø20,Ø25,Ø30,Ø32,Ø38,Ø49 (Support Customization)

## Transparent PVC/PET TAG

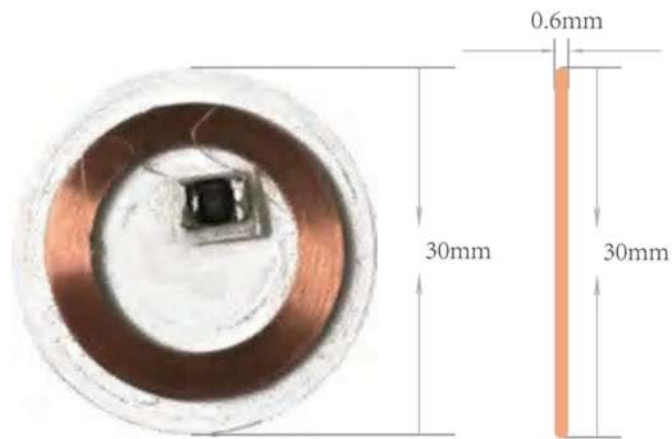

Product introduction

Material:PVC/PET

Color: white/transparent(The surface can be printed)  
Size: customizable(Ø15,Ø18,Ø20,Ø25,Ø26,Ø27,Ø30,Ø32, Ø38,Ø49)

Feature

Surface can be customized pattern,The back can be affixed to the surface of the article

Application: Used in access control, meeting sign, product identification, logistics tracking, biometrics, item identification, industrial automation, card payment

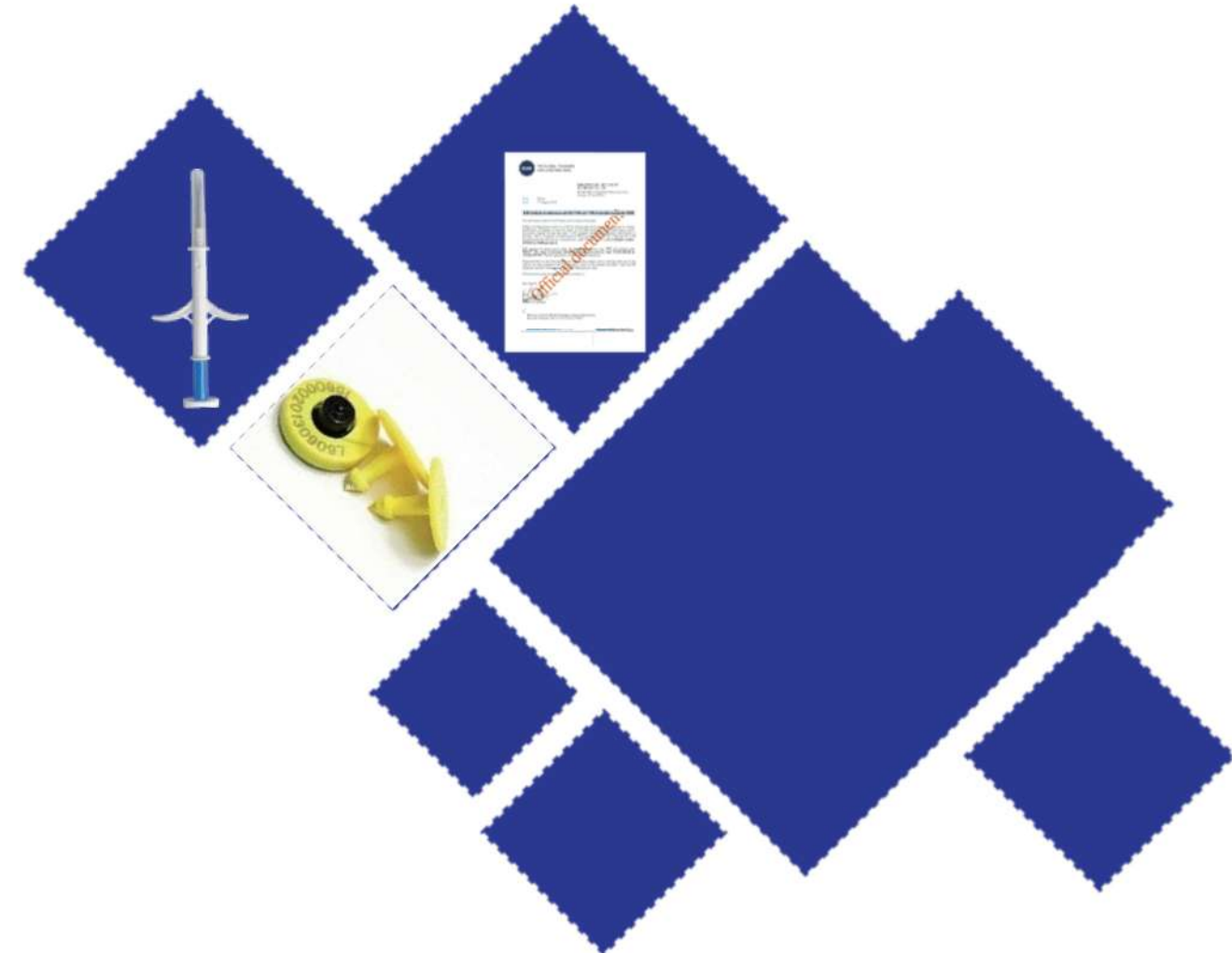

### Simple Needle Packing

OPTIONAL COLOR 



MORE STYLES, CAN BE CUSTOMIZED

### Chicken Leg Ring Tag

OPTIONAL COLOR 

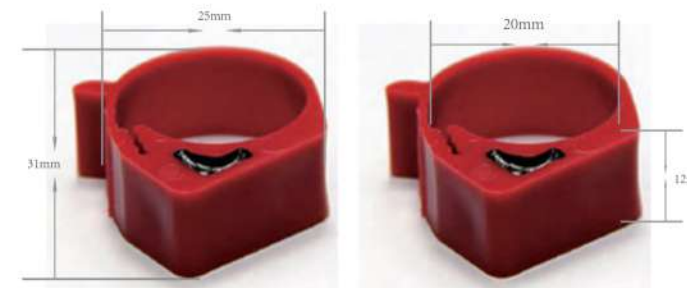

Size:inside diameter 20\*12mm

MORE STYLES, CAN BE CUSTOMIZED

**Product Introduction**  
**Material:**ABS  
**Color:** red yellow blue and many other colors  
**Size:**inside diameter20\*12mm,inside diameter17.5mm\*13mm  
**Way of encapsulation:**Epoxy potting  
**Encoding format:**EMID format,Animal coding format  
**Read range:**2-20cm(Read and write device configuration)  
**Features:**  
 Epoxy potting, waterproof, drop resistance, anti-shock  
**Chip types:**TK4100,EM4305,EM4200,T5577,HDX7999, HITAGS256.  
**Working temperature:**-20-50°C  
 Widely used in the identification of poultry, animal management, poultry breeding, breeding / epidemic prevention and control, Information management of animals and poultry, and traceability of food.

ANIMAL TAG

ANIMAL TAG

### Pigeon Leg Ring Tag

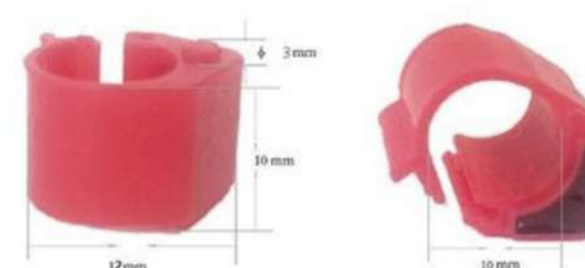

Size:inside diameter 12\*10mm



**Product Introduction**  
**Material:**ABS  
**Color:** red yellow blue and many other colors  
**Size:**inside diameter12\*10mm  
**Way of encapsulation:**Epoxy potting  
**Encoding format:**EMID format,Animal coding format  
**Read range:**2-20cm(Read and write device configuration)  
**Feature**  
 Epoxy potting, waterproof, drop resistance, shock resistance.  
**Chip types:**TK4100,EM4305,EM4200,T5577,HDX7999,HITAG S256  
**Working temperature:**-20-50°C  
**Application:**Widely used in the identification of poultry, animal management, poultry breeding, breeding / epidemic prevention and control, pigeon match quarantine and other animal and poultry informatization management tracking and traceability of food.

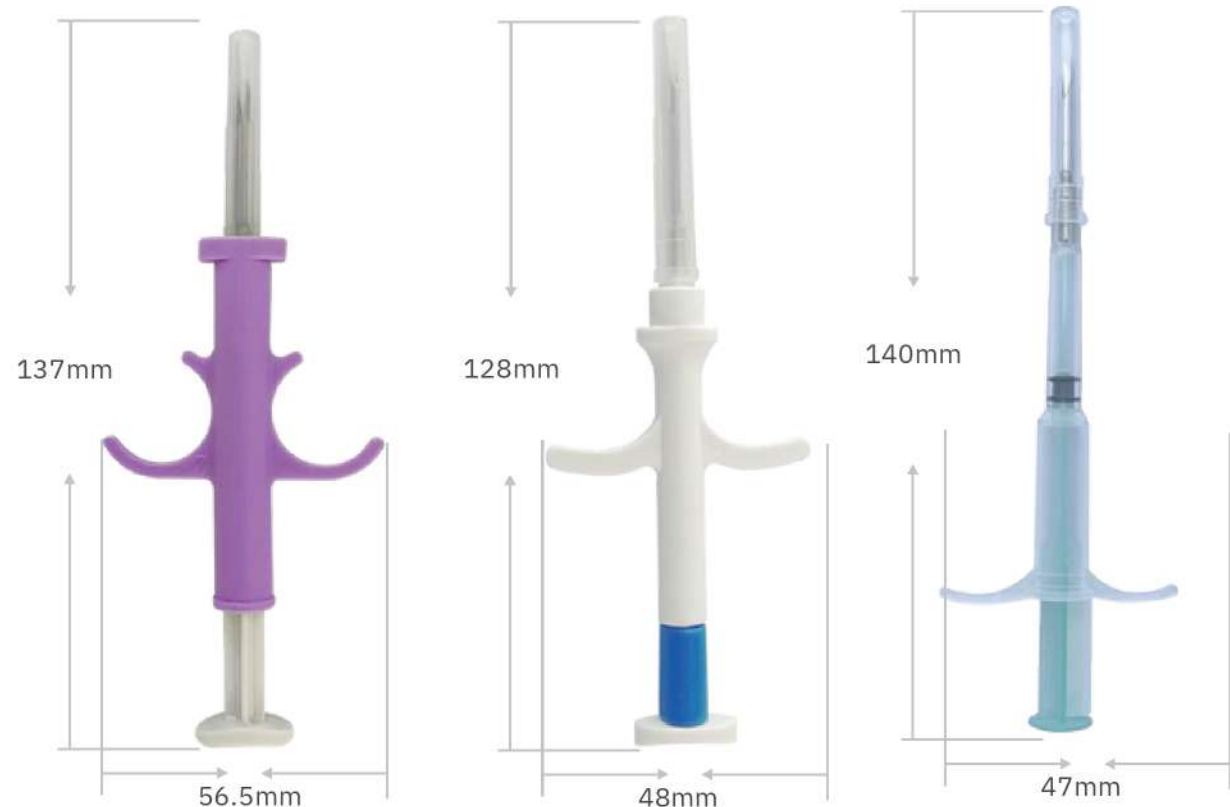
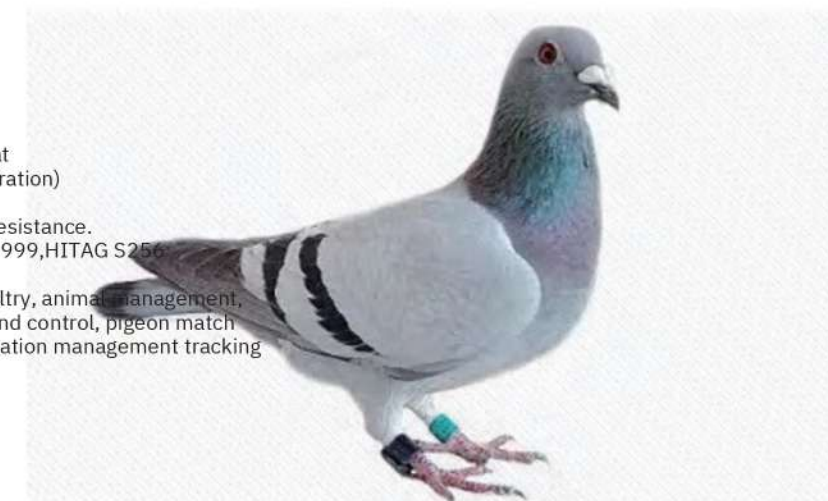

### THROUGH HOLE / SEAL EAR TAG(E01/02)

OPTIONAL COLOR



MORE STYLES, CAN BE CUSTOMIZED



Product Introduction Material:TPU+PA  
Color:yellow,bule(customizable)

Feature 1.This product is safe non-toxic, no smell, no irritation, no pollution, chemical stability of the sun, no cracking, long life, do not stimulate

the skin 2.Anti-hit, in line with IEC68-2-27, anti-vibration, in line with IEC68-2-6, the main standard and auxiliary standard combination of strong, shedding force greater than 200N, electronic identification of a single piece of the overall stretch, the identification of the fracture force greater than 230N

3.Frequency:LF/HF/UHF  
4.Working temperature:-30-80°C

Application:Widely used in animal husbandry, laboratories, pet hospitals, etc., can be nailed to animal ears for animal management, population breeding, epidemic prevention, quarantine, rare species tracking.



### SHOVEL EAR TAG(E03)

OPTIONAL COLOR

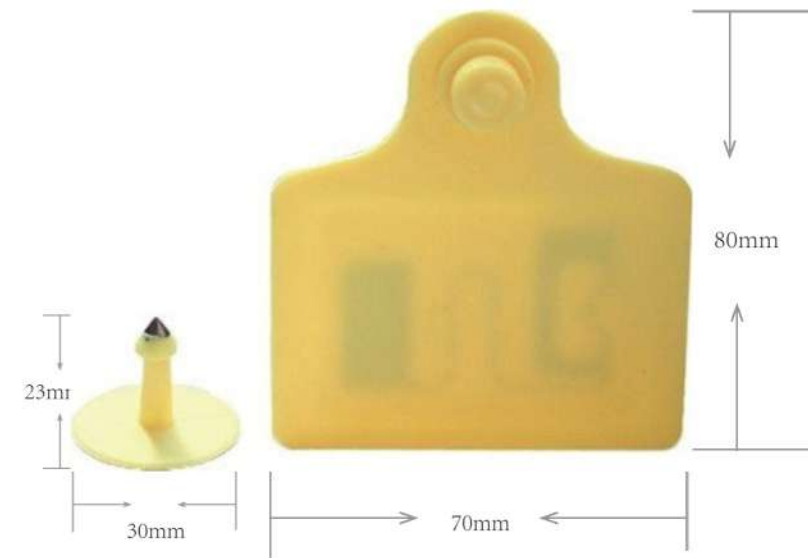

MORE STYLES, CAN BE CUSTOMIZED



Product Introduction  
Material:TPU  
Color:yellow,bule(customizable)  
Size:Female tag(70\*80mm,100\*74mm)  
Male tag(30\*23mm)

Feature  
Chemical stability, non-toxic, waterproof, no smell, wear resistance, no cracking, long life, do not stimulate the skin  
Chip Types:ALIEN H3,IMPINJ M4/M5  
Working temperature:-20-80°C  
Read range:1-7m(Depending on the reader antenna)

### UHF male tag(E04)



## Cattle Ear Tag(E06)



MORE STYLES, CAN BE CUSTOMIZED



Product Introduction Material:TPU  
Color:yellow,bule (customizable)  
Size: customizable (45\*20mm,113\*80mm)

### Feature

This product is safe non-toxic, no smell, no stimulation, no pollution, chemical properties, stability, anti-sun, no cracking, long life, do not stimulate the skin

Application: Livestock husbandry, laboratory, pet hospital and so on Can be nailed to animal ears for animal management, population breeding, epidemic prevention, quarantine, rare species tracking



## Injectable Microchip Tag



MORE STYLES, CAN BE CUSTOMIZED



### Product Introduction

Material:Biochemical glass  
Size: 1.25\*7mm,1.4\*8.5mm,1.5\*8mm,2.12\*8mm,2.12\*12mm,3\*15mm  
Disinfection method: EO disinfection, valid for 5 years  
Feature  
Small size, light weight, simple injection, the use of bio-glass package with anti-sliding surface material. Will not be excluded in the animal body, will not be infected  
Chip types:TK4100,EM4305,EM4200,T5577,HDX7999,HITAG S256, NTAG216,I CODE SLI  
Working temperature:-20°C-80°C  
Application:Widely used in cats, dogs, experimental mice, pet mink, Arowana, fish, horses, rabbit tracking, etc.

OPTIONAL COLOR 

### Plastic cable ties tag

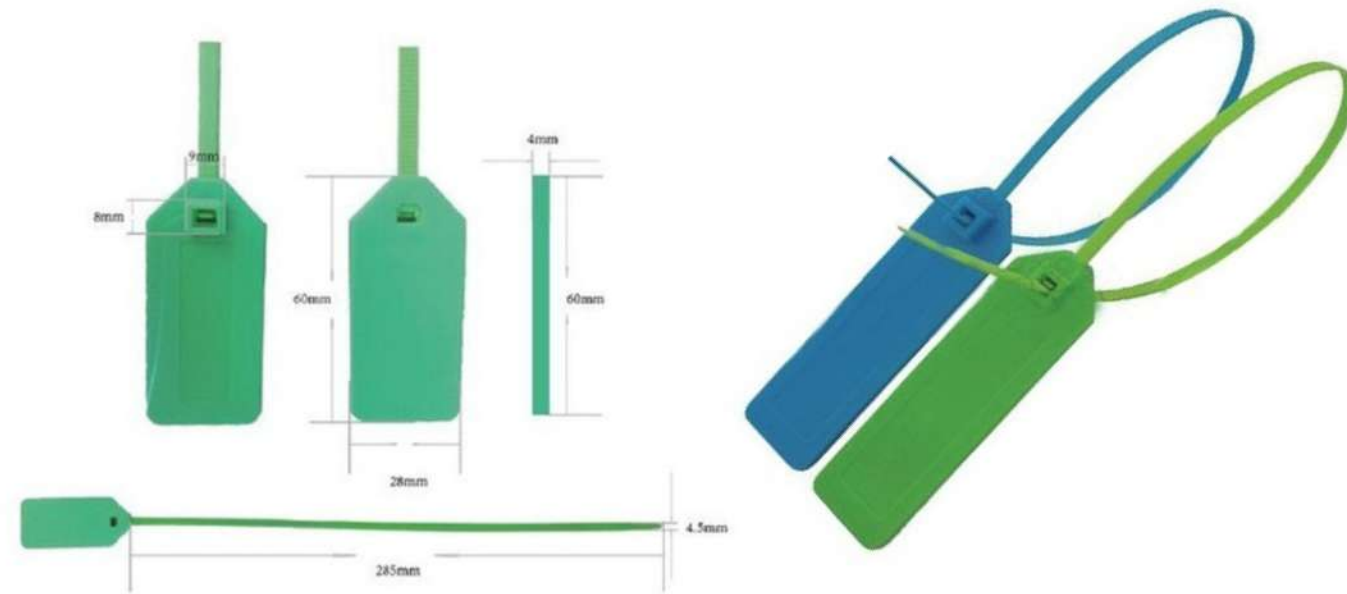

MORE STYLES CAN BE CUSTOMIZED

OPTIONAL COLOR 

### Waste bin tag

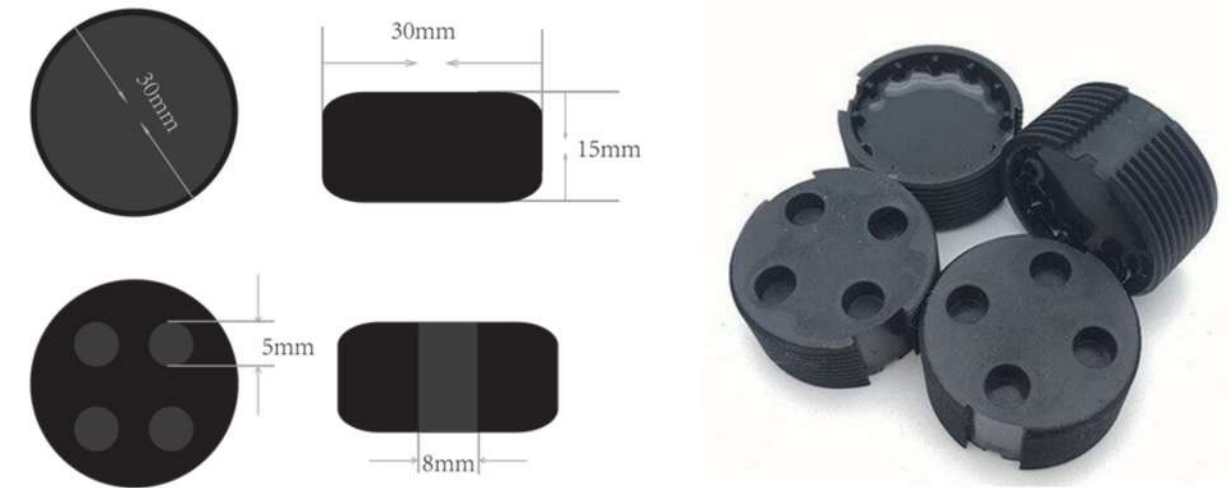

MORE STYLES CAN BE CUSTOMIZED

### Thick with sign



SIZE: 87.5\*54.5\*6.5mm

### Grid tie



Product Introduction Material:ABS+PA, TPU Colour: green(customize acceptable) Product Features Waterproof, prevent collision and broken, anti acid ,durable features, The buckle is buckled , striped tape easy insert but can't be withdrawn , The buckle effect is excellent. The chip is in the outer position of the tag binding, without being affected by the material of the strapped , reading information stably . Chip types: TK4100, EM4200, FM11RF08,NXP S50NXP S70, compatible S70, I CODE SLI, ULTRALIGHT,ULTRALIGHT C, NTAG 213/215/216, D21,D41, D81, ALIEN H3 Working temperature: -20-50 °C Application: container,warehouse logistics, air parcel, production automation management and other similar RFID field.

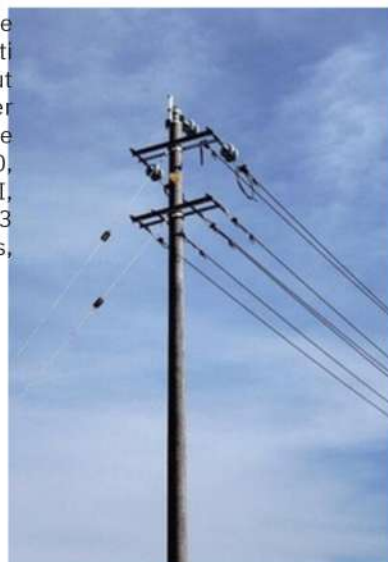

Product Introduction Material: PA66+epoxy Colour: black, orange(customizable) Features Waterproof,Moisture resistance , shock resistance, heat resistance,fix with screw, does not affect the use of waste bin. Chip Type:TK4100, EM4200, EM4305, T5577, HDX 7999, HITAG S256, FM11RF08,NXP S50, 国产S70, ICODE SLI,ULTRALIGHT,ULTRALIGHT C,NTAG213/215/216, D21, D41 , D81, ALIEN H3 Working temperature:-20-120°C Application:waste bin tracking and record



OPTIONAL COLOR 

### RFID Full Epoxy Tag



Product Introduction  
 Colour: Customizable  
 Material: PVC + Epoxy  
 Size: 88\*45mm, 30\*50mm

MORE STYLES CAN BE CUSTOMIZED

### NFC Ultra-narrow Frame



OPTIONAL COLOR 



MORE STYLES CAN BE CUSTOMIZED

### RFID/NFC Barcode Epoxy PET Tag



Product Introduction  
 Material: PVC+ Epoxy  
 Colour: customizable

Features: NFC PET Tags are a great and fun NFC product for our pets. It has an NFC chip inside that can store various information about your dog in the tag. There's enough memory to store multiple contact numbers, home addresses, email addresses, social accounts, custom messages, and more. It can be read by all NFC phones.  
 Chip types: FM11RF08, NXP S50/NXP S70, compatible S70, I CODE SLI, ULTRALIGHT, ULTRALIGHT C, NTAG 213/215/216, D21, D41, D81.

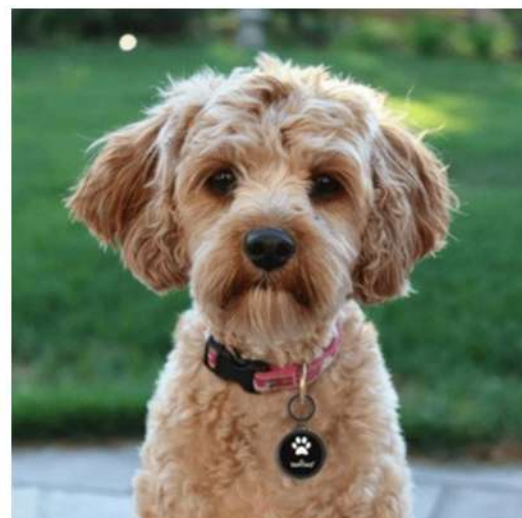

Product Introduction  
 Colour: Customizable  
 Features: 1.25mm ultra-narrow frame, tag shape, color, and chip can be customized.  
 Chip Type: FM11RF08, NXP S50/S70, ICODE SLIX, ULTRALIGHT, ULTRALIGHT C, NTAG213/215/216  
 Application: Tags can be embedded in narrow spaces such as Electronic Products, Tools, and Toys for Automatic Identification, Anti-Counterfeiting and Traceability, etc.

